

Everything's possible.

Products & Capabilities Overview

Servo Drives | Controls | Custom Solutions

a-m-c.com



About **ADVANCED** Motion Controls

ADVANCED Motion Controls has earned a reputation for being the most flexible and affordable manufacturer of quality high performance and high power density servo drives. Camarillo California is home to our state-of-the-art 86,000 ft² (m²) facility that integrates Engineering, Manufacturing, Testing and Support in a single location. By selecting ADVANCED Motion Controls as your servo drive and controls supplier, you will be adding an integral member to your design engineering team with multi-industry expertise.

30+ Years of Excellence

30+ years of servo drive manufacturing, with nearly 3 million servo axes built and shipped worldwide!



Any: Motor, Controller, Feedback, Network, Environment, Industry, Application!

Our servo drives and controls can be found all over the world in the highest performance applications and the harshest environments, as well as working reliably in day-to-day operations. With hundreds of readily available models as well as offering modifications to existing products and complete custom solutions, ADVANCED Motion controls has the solution to any servo application!





4 Industry Experience
from wire cutting to robotics
and everything in between



**5 FlexPro™
Servo Drives**

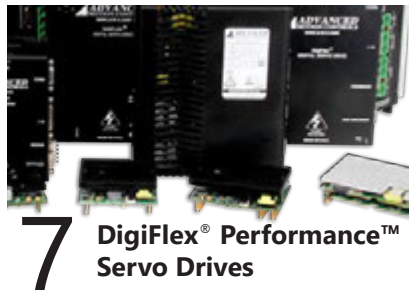

**7 DigiFlex® Performance™
Servo Drives**



**19 Click&Move®
Automation Solution**
full featured motion controller,
PLC and HMI



29 Custom Solutions
for space constraints, EMI,
temperature, increased power,
more...

Contents

Our Company	1
Technologies and Product Capabilities	3
Industry Experience	4
FlexPro™ Servo Drives	5
The next-generation in digital servo drive design, delivering an expanded feature set and our smallest form factor yet.	
DigiFlex® Performance™ Servo Drives	7
Powerful, versatile, network-capable servo drives with universal servo motor compatibility through automcommutation.	
AxCent™ Servo Drives	9
Proven, reliable servo architecture allowing a cost-effective, simple approach to centralized control schemes.	
M/V™ Series Vehicle Mount Motor Controllers	11
Fully functional servo drives purpose designed and built for electric mobility and vehicular applications.	
Extended Environment Servo Drives	13
Ruggedized servo drives designed for harsh environments and extreme ambient temperatures.	
Model Selection Tables	
DigiFlex® Performance™ - panel and vehicle mount	15
DigiFlex® Performance™ - pcb mount	16
AxCent™ - panel and vehicle mount	17
AxCent™ - pcb mount	18
Click&Move® Automation Solution	19
An automation solution for motion control designed for OEMs, systems integrators, and end users.	
DriveLibrary™	23
A motion control API using a pre-defined set of motion functions for simple C++ motion programming.	
Configuration Software (ACE™ and DriveWare®)	25
Drive configuration software with embedded motion controller functionality for Indexing and Sequencing.	
Customs Capabilities	27
Customs Process	28
Example Custom Solutions	29

Visit a-m-c.com for Company Information, Product Datasheets, Installation Manuals and Downloads.

Our Company

ADVANCED Motion Controls offers a wide range of motion solutions that provide reliability and high performance in any motion control system.



- Servo Drives
 - » 10-800 VDC and 115, 230, 460 VAC
 - » mA to 250A with high efficiency
 - » Small, compact, high power density
 - » Plug-in, panel mount, vehicle mount, multi-axis
 - » Functional Safety, extended environments, and IP65
 - » Networks:
 - CANopen®, EtherCAT®, POWERLINK, Modbus, Ethernet, and others...
 - » Commands:
 - Analog, Over the Network, PWM/DIR, STEP/DIR, and more...
- Machine Controls and I/O
 - » Click&Move®
 - » Multiple target platforms:
 - Stand-alone, PC-based, or embedded
 - » Scalable number of axes and drive power needs
- System accessories
- Complete customs or modified products
 - » 1/3-1/3-1/3 mix of standard, modified and custom solutions
- 40 sales partners with 300+ associates and 130+ support engineers worldwide
- Everyone passionate about your success!



ADVANCED Motion Controls has extensive experience in designing affordable custom products optimized for OEM's specific needs. Whether a simple modification to a standard product or a completely custom design, we can support and sell custom solutions as if they were standard products.

Examples of Customized Products and Options

- | | |
|--------------------------------|-----------------------------------|
| ◦ Optimized Footprint | ◦ Tailored Project File |
| ◦ Private Label Software | ◦ Silkscreen Branding |
| ◦ OEM Specified Connectors | ◦ Optimized Base Plate |
| ◦ No Outer Case | ◦ Increased Current Limits |
| ◦ Increased Current Resolution | ◦ Increased Voltage Range |
| ◦ Increased Temperature Range | ◦ Conformal Coating |
| ◦ Custom Control Interface | ◦ Multi-Axis Configurations |
| ◦ Integrated System I/O | ◦ Reduced Profile Size and Weight |



Feel free to contact our Applications Engineering department for more information on custom solutions!



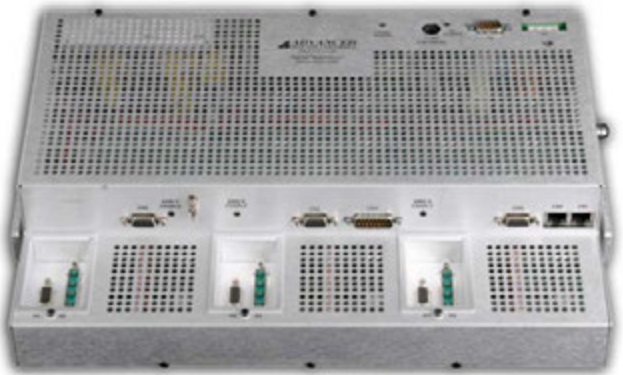

ISO9001
CERTIFIED

An ISO 9001 certified online documentation workflow insures accuracy and consistency throughout design, manufacturing, testing, and support of all products.

Our manufacturing facility was specifically designed to integrate Engineering, Manufacturing, Testing and Support in a single location giving us unmatched scheduling flexibility and quality control. Prototypes are built on the same line using the same equipment as production units enabling rapid development, fast delivery and exceptional reliability for OEMs.



Engineering to engineering interaction with our customers is key to our ability to address your technical and technology needs. By selecting *ADVANCED* Motion Controls as your servo drive supplier you will be adding an integral member to your design engineering team with multi-industry expertise. Often we make suggestions that weren't considered by the customer so as to make a better product than what may have originally been conceived. We help bring great new products to the market faster.

- Customers have direct access to engineering staff
- 40% of 140+ employees are engineers

Factory visits are our unfair advantage to impress our customers. On-site inspections of our manufacturing facilities and quality audits are encouraged! With a single visit you will gain an understanding of the company structure, our way of working and our capabilities.



Technologies and Product Capabilities



Combining cutting-edge technology and creative engineering, *ADVANCED* Motion Controls is able to design and manufacture high quality servo drives capable of delivering high power at a low cost. As the demands of the motion control industry have increasingly asked for better performance, more features, and simplified integration, *ADVANCED* Motion Controls has responded by finding resourceful solutions to the problems faced by OEMs and servo system designers. Whether by implementing innovative design techniques throughout our line of standard products, or by directly solving a specific customer's application with a brand-new custom product, *ADVANCED* Motion Controls has the drive expertise to take on your servo system challenge.

Any Network

CANopen

EtherCAT

ETHERNET
POWERLINK

Ethernet

RS-485/232
SERIAL

Modbus

We also have the ability to quickly produce custom DigiFlex® Performance™ drives utilizing many other common types of network communication.

Any Motor

- **Three Phase (Brushless)**
 - » Servo - BLDC, PMAC
 - » AC Induction (Closed Loop Vector)
 - » Closed Loop Stepper
- **Single Phase**
 - » Brushed
 - » Voice Coil
 - » Inductive Load

Any Feedback

- **Absolute Encoder**
 - » EnDat®
 - » Hiperface®
 - » BiSS® C-Mode
- **1Vp-p Sin/Cos Encoder**
- **Incremental Encoder**
- **Aux. Incremental Encoder**
- **Hall Sensors**
- **Resolver**
- **±10VDC Position**
- **Tachometer**
 - » ±10VDC
 - » ±60VDC

Any Controller

- **Digital or analog controllers**
 - » ±10V Analog
 - » PWM and Direction
 - » Step and Direction
- **Vehicle Specific Commands**
 - » 0-5V (Standard, Inverted, or Wigwag)
 - » 0-5kW (Standard, Inverted, or Wigwag)

Any Environment

- **Extreme Ambient Temperatures**
 - » Standard products range from -40°C to +85°C
 - » Custom products operate down to -50°C and lower, and +100°C and higher!
- **Component Temperature Protection**
 - » PCB operating temperatures up to 105°C
- **Shock and Vibration**
 - » Up to 15g's at 11ms
 - » Up to 30grms on all 3 axes



**UNIVERSITY
OUTREACH**

ADVANCED Motion Controls' University Outreach program provides cost-reduced and free servo drives to future generations of engineers and motion control system designers for university and research applications. Hundreds of academic projects at educational institutions worldwide have taken advantage of University Outreach to achieve success with their motion control endeavor. To learn more about the opportunities available and to see past successful student projects visit www.a-m-c.com

Industry Experience



Any Application, Any Industry

ADVANCED Motion Controls is able to utilize our extensive experience in providing high performance servo drives to support motion control applications in numerous industries. With an ever-expanding customer base across new and emerging fields, and having been established as a top supplier for traditional servo solutions, ADVANCED Motion Controls brings our wealth of diverse motion control knowledge to a wide variety of industries, including but not limited to:



Assembly Automation and General Factory Machinery



Communications Control



Electric Mobility and Mobile Robotics



Entertainment



Homeland Security and Defense



Inspection Testing and Rapid Prototyping



Lab Automation



Machine Tool and Metalworking



Material Handling and Conveyed Systems



Medical



Packaging



Power Generation and Alternative Energy Sources



Robotics (fixed)



Semiconductor

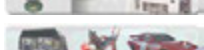

Simulators



Introducing our...

Smallest,

Most Versatile,

Most Advanced,

...Servo Drives to date!

FlexPro™

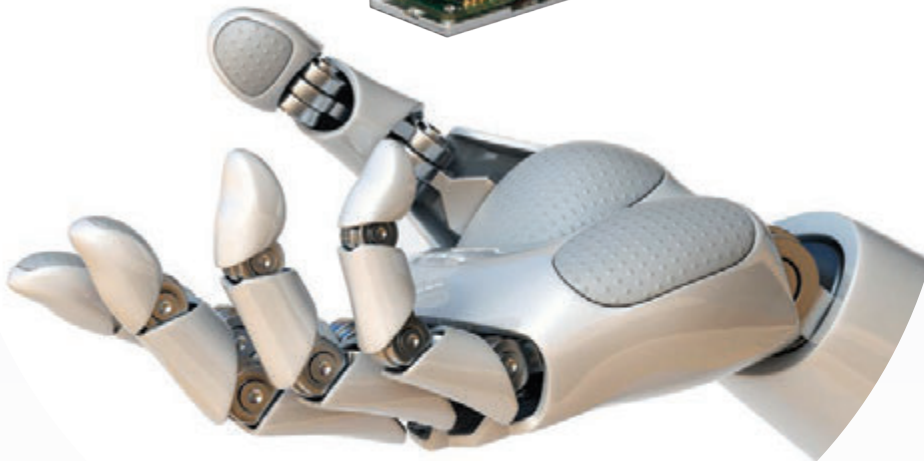
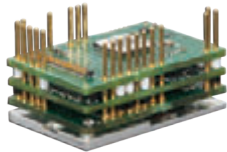

We're in a new era of motion control where advancements in robots and automation are accelerating at a rapid pace.

There is a growing demand for smaller, more versatile, and higher power servo drives that are designed to easily integrate into ever-tightening constraints.

We have accepted the challenge and answered the call!

Introducing a new family of drives, FlexPro™.

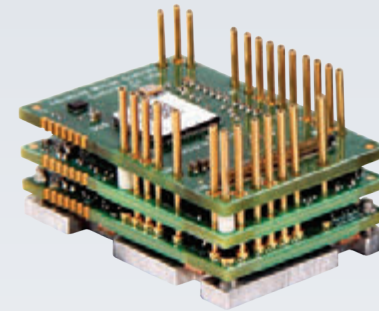

FE060-25-EM - Actual Size!

Upcoming support for...

- CANopen, RS485, other Ethernet fieldbuses
- Absolute (EnDat, Hiperface), Sin/Cos, and Resolver feedback
- Open Loop Stepper Motor Support
- Higher power levels
- Building block for modifications and complete custom solutions

Perfect for...

- Cobots
- Warehouse Robots and AGVs
- Portable/Mobile Devices
- Integrated Designs
- Lab Automation
- ...And endless others!

The FlexPro™ family of drives are made possible by our new **IMPACT™** architecture. IMPACT stands for **Integrated Motion Platform And Control Technology**. It's this new architecture that allows FlexPro™ drives to fit into tight spaces and still deliver the impressive power and performance to your robot joints, AGV traction wheels, or any other application. In addition, the advanced processing and storage capabilities ensure that drives with IMPACT™ are more intelligent and operationally flexible than ever before.

IMPACT™ isn't exclusive to FlexPro™ drives - this new architecture can be used for our custom products too.

With rapid development into higher power and expanded network options, more FlexPro™ models are on the way. The motion control industry continues to evolve and expand every year, and as veterans of the industry, it's up to us to develop quality solutions for its new demands. The FlexPro™ family and IMPACT™ are our answer to those demands.



PCB mount FlexPro™ Servo Drive Models

Example model numbers: FE060-25-EM, FM100-25-CM

Form Factor		Combine to form model number	Power Modules	Supply (VDC)	Peak Current (A)	Cont. Current (Arms)	Functional Safety	Dimensions (mm)	Combine to form model number	Network Communication		Feedback Type	
										E	IP	C*	R*
PCB Mount	FE	←	060-5	10-55	10	5	STO	38 x 25 x 16	→	E	EtherCAT	M	Multi-encoder (BiSS, 5V Incremental)
Machine Embedded	FM		060-10	10-55	20	10	STO	38 x 25 x 16		IP	Ethernet IP		R*
w/Development Board	FD		060-25	10-55	50	25	STO	38 x 25 x 16		C*	CANopen		
			060-50	10-55	100	50	STO	38 x 25 x 16		R*	RS485		
			100-25	10-80	50	25	STO	38 x 25 x 16					
			200-15	40-175	30	15	STO	38 x 25 x 16					

*Scheduled for 2020 release dates. Inquire for estimated delivery. Final specifications TBD.

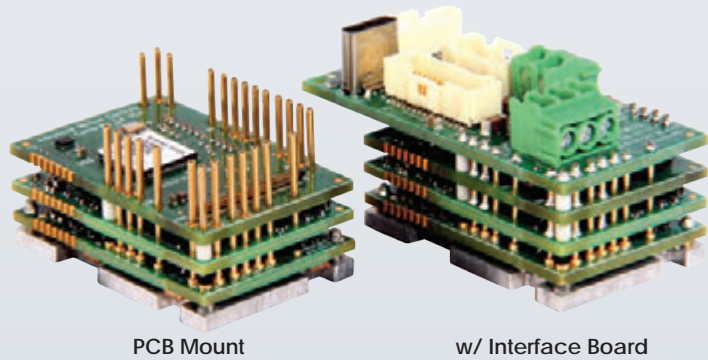

PCB Mount

w/ Interface Board

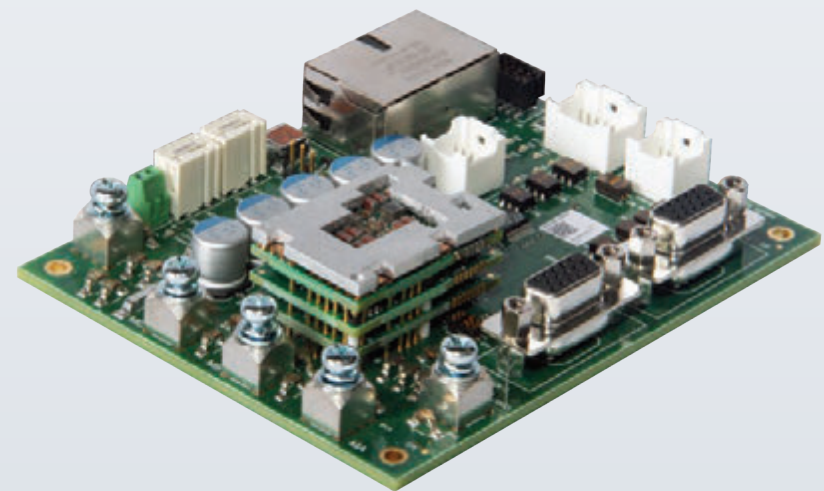

w/ Development Board

DigiFlex® Performance™ Servo Drives

The family of DigiFlex® Performance™ servo drives provide a wide range of options for servo system solutions. DigiFlex® Performance™ (DP) drives deliver peak power output up to 27.4kW, and support an array of feedback options. Driving three phase brushless (servo, closed loop vector, closed loop stepper) and single phase (brushed, voice coil, inductive load) motors with the ability to interface with both digital network commands and traditional ±10V analog commands, DP drives offer a versatile blend of cutting edge technology and proven results.

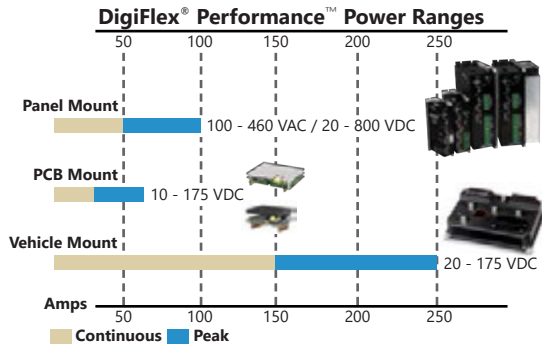

Network Options

CANopen

» CANopen - CiA 301 Communications Profile and 402 Device Profile

EtherCAT

» EtherCAT - ETG.1000.6 EtherCAT Application Layer protocol specification and the ETG.6010 Implementation guideline for CiA 402 Device Profile (CoE)

ETHERNET POWERLINK

» POWERLINK - EPSG DS301 Communication Profile Specification Version 1.2.0

Modbus

» Modbus TCP/RTU - Open standard application-layer messaging protocol providing query-response communication over a serial line or on an Ethernet network

RS-485/232 SERIAL

» RS485 - ADVANCED Motion Controls' proprietary serial protocol, a byte-based, binary, master-slave standard to access drive commands

Ethernet

» Ethernet - ADVANCED Motion Controls' proprietary protocol over Ethernet UDP or TCP

- **Universal servo motor capability by means of automatic commutation adjustment**
- **Variety of feedback options - Absolute Encoder (EnDat®, Hiperface®, BiSS® C-Mode), Incremental Encoder, Hall Sensors, Resolver, 1Vp-p Sin/Cos Encoder, Tachometer**
- **Full tuning control of Position, Velocity, and Torque Loops**
- **Functional Safety (STO) Inputs available on select models - suitable for use in safety-related systems according to:**
 - » EN 62061 / IEC 61508 SIL 3
 - » EN ISO 13849-1 Category 4 / PL e



- **Motion Engine - embedded motion controller functionality that allows Indexing, Sequencing, and other motion tasks**
 - » Create up to 16 Relative or Absolute Index tasks and up to 16 Sequences to initiate on power-up, via network command, or digital inputs
 - » Execute Dynamic Indexes, Jogs, PVT Profiles, or Homing Routines
 - » View real-time motion profile data
- **Compatible with DriveLibrary™ - ADVANCED Motion Controls' API for C++ motion programming**
- **Real-time oscilloscope for high-performance tuning**
- **Status panel for drive and system diagnostics**
- **I/O configuration for over 60 events and signals**
- **Dual loop feedback and control - increases stability and accuracy**
- **Stand-alone or network configuration**
- **Extended Environment versions available (DZX series Z-Drives)**



DIGIFLEX® PERFORMANCE™ SERVO DRIVES



Any Controller



Any Motor



Any Feedback



Any Application



Any Network



Any Environment



Any Industry



ADVANCED Motion Controls' Exclusive Innovations in EtherCAT® Connectivity



'DxI/O'™ Technology accommodates 70 additional digital and analog I/O points for each axis in a 'DxM' configuration, up to 280 I/O total!

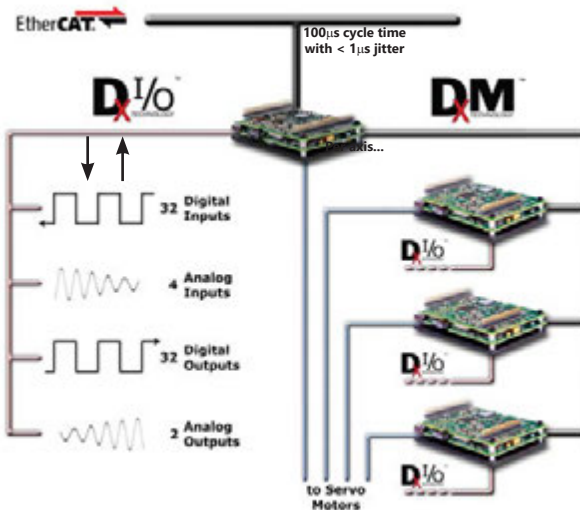

'DxM'™ Technology allows connectivity of up to 3 DZS (sub-nodes) to a single DZE (node) on an EtherCAT® network, providing control of up to 4 axes of servo motion at a reduced cost.

Up to 280 Inputs and Outputs with 4 Axes of Motion

AxCent™ Servo Drives

ADVANCED Motion Controls' AxCent™ family of servo drives provide unparalleled benefits in both simplicity and performance. Drive setup and operation does not require computer hardware or software, and achieves higher bandwidth and faster response times at a lower cost. Analog drive technology has been a staple of servo system solutions since day one, and our years of experience in building the highest quality products has created a solid and continuously improving selection of analog drives. A variety of command options, including $\pm 10V$ analog, PWM and Direction, and specialized electric vehicle commands make ADVANCED Motion Controls' AxCent family of drives your best choice for proven servo solutions.

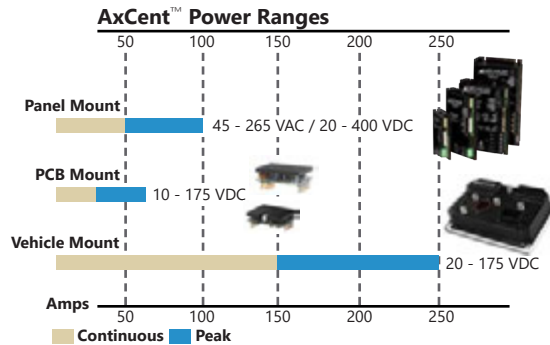

Input Command Signals

$\pm 10V$ Analog

» Single-ended or differential $\pm 10V$ analog input command used to adjust the motor current, voltage or speed.

Controller Output

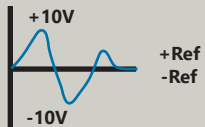

PWM & Direction

» Torque Mode PWM - The PWM signal is converted to an analog voltage in the drive used as the command signal into the current loop (similar to current mode in other products). The input duty-cycle controls the drive's output current.

Controller Output



- **Built-in hardware protection - Over Current, Over Voltage, Under Voltage, Over Temperature, Short Circuit**
- **DIP Switches and Potentiometers for loop tuning, current limit adjustments and drive configuration**
- **Standard models support both brushless and brushed motor varieties**
- **Velocity feedback provided via incremental encoder, Hall Sensors, or tachometer**
- **Optical isolation between high and low power signals standard on certain models**
- **Current, Velocity, and Fault Monitor analog output signals**
- **Status LEDs for power and drive status**
- **Standard models in both Panel Mount, PCB Mount (Z-Drives), and Vehicle Mount (M/V™ Series Motor Controllers)**
- **Four quadrant regenerative operation**
- **Extended Environment versions available (AZX series Z-Drives)**



AXCENT™ SERVO DRIVES

AXCENT™ SERVO DRIVES



Simplicity



Proven Track Record



Performance

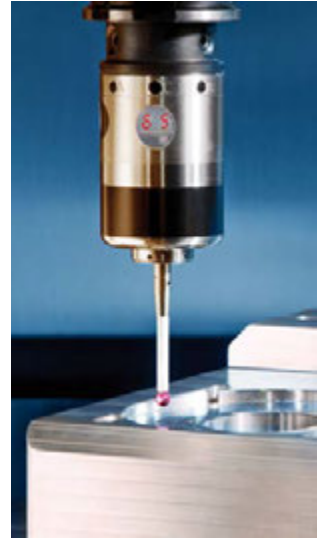

Operating Modes

- » Current (Torque) - input command voltage controls the output current.
- » Duty Cycle (Open Loop) - input command voltage controls the output PWM duty cycle.
- » Hall Velocity - input command voltage controls the motor velocity, with the Hall Sensor frequency closing the velocity loop.
- » Encoder Velocity - input command voltage controls the motor velocity, with the Encoder pulse frequency closing the velocity loop.
- » Tachometer Velocity - input command voltage controls the motor velocity, with a DC tachometer closing the velocity loop.
- » Voltage - input command voltage commands a proportional output voltage regardless of power supply voltage variations.
- » IR Compensation - input command voltage commands a proportional output voltage, adjusting for load torque variations.

Advanced Tuning

Certain AxCent™ models feature advanced tuning capabilities useful for fine-tuning both the current and velocity loop response behavior. Advanced tuning is accomplished via DIP Switches and allows the user greater flexibility and control of their application. Available advanced tuning settings are:

- » Additional current loop proportional gain resistance
- » Additional current loop integrator capacitance
- » Additional velocity integrator capacitance

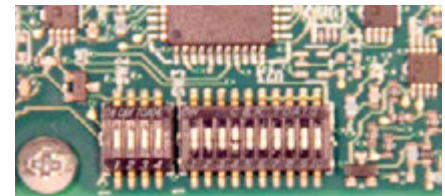

M/V™ Series Vehicle Mount Motor Controllers



ADVANCED Motion Controls' family of M/V™ series vehicle mount motor controllers are fully functional, four-quadrant servo drives purpose designed and built to operate today's modern mobile electric vehicular platforms. Available in both AxCent and DigiFlex Performance versions and packaged in a compact and rugged IP65 case, M/V series motor controllers provide high power from battery supplies for either permanent magnet brushed or brushless motors. Whether for traction / propulsion, steering, lifting, or any other electrically driven actuation, the unmatched power density, high efficiency, low weight, built-in regen, and cool thermal operation of M/V series motor controllers provide optimum performance for mobile electric vehicular applications.



20-54 VDC 250 A. peak 150 A. cont	20-80 VDC 200 A. peak 125 A. cont	40-175 VDC 125 A. peak 80 A. cont	40-175 VDC 100 A. peak 100 A. cont
---	---	---	--



Functional Safety Type Approved

www.tuv.com
ID 060000000

- AxCent™ (AVB, AB) and DigiFlex® Performance™ (DVC) models provide solutions for a wide range of command, configuration, and network options
- Selectable throttle command inputs: 0-5V or 0-5kΩ
- Standard and vehicle-specific I/O for over 60 events and signals
- Compact, Rugged, Vehicle Mount Design - IP65 Rating
- Functional Safety (STO) Inputs available on select models - suitable for use in safety-related systems according to:
 - » IEC 61508 SIL 3
 - » EN ISO 13849-1 Category 4 / PL e
- Watertight I/O, signal, and feedback connector
- Watertight access panel for drive configuration and setup
- Selectable modes of operation
- DVC models configurable through DriveWare® 7, offering the same capabilities of DigiFlex® Performance™ digital servo drives
- AVB and AB models configurable through DIP Switches and potentiometers



M/V™ SERIES MOTOR CONTROLLERS



Throttle Command Inputs

M/V series motor controllers are configurable for a variety of different throttle command types common in electric vehicular applications. Each command type is user-selectable as standard single-ended, inverse single-ended, wigwag, or inverse wigwag.

0-5V Analog Voltage

On DVC and AVB models, an external 0 - 5 volt supply provides the command input source.

0-5kΩ Potentiometer

On DVC and AVB models, an external 5kΩ potentiometer can be used in either a 3-wire or 2-wire configuration to provide the command source.

±10V Analog

On DVC and AB models, an external or on-board ±10 volt supply provides the command input source.

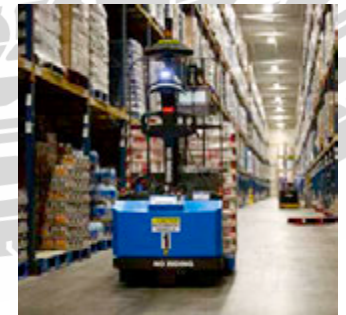

Vehicle Specific I/O

M/V series motor controllers feature unique programmable and dedicated inputs and outputs designed with mobile electric vehicular applications in mind.

- Key Switch / Main Contactor Operation
- Electromagnetic Holding Brake Output
- Speed Limit Input
- Reduced Speed Reverse
- Forward / Reverse Inputs
- "Push" (Neutral) Input
- Horn / Reverse Alarm



Extended Environment Servo Drives



ADVANCED Motion Controls' Extended Environment products are designed to operate under harsh thermal and mechanical extremes. An expanded thermal operating range allows these drives to function in both hot and cold ambient environments, and enhanced protection against shock and vibration provides additional system ruggedness. Extended Environment drives also afford benefits for applications in more docile conditions. The superior thermal capabilities reduce or eliminate the need for cooling systems such as external heat sinks and fans, enabling system designs to be more compact and to improve overall reliability.

Shock

&



-40°C
-40°F

Extended Environment

+85°C
+185°F



- Ambient operating temperatures ranging from -40°C to 95°C (-45°F to 203°F)
- Over Temperature heat sink protection up to 105°C (221°F)
- Thermal rise cycling in about 2 minutes
- Shock up to 15g's at 11ms
- Vibration up to 30grms on all 3 axes
- Standard models in PCB Mount (Z-Drives) form factor - Panel Mount models available as custom designs
- Designed to assist system compliance toward:
 - » MIL-STD-810F: temperature, thermal shock, humidity, altitude, shock & vibration
 - » MIL-STD-1275D: characterization of 28VDC systems
 - » MIL-STD-461E: control of electromagnetic interference
 - » MIL-STD-704F: aircraft power characteristics
 - » MIL-HDBK-217: reliability predictions
- Tested to meet above standards upon customer request

DZ^X series

- » DigiFlex® Performance™ Z-Drives
- » User selected I/O and Event Handling
- » Configurable limits & gains
- » Distributed network control
- » Comprehensive diagnostics

AZ^X series

- » AxCent™ Z-Drives
- » Highest bandwidth possible
- » Dedicated operating modes
- » Simplest installed platform

F^X series

- » FlexPro™ Drive Family
- » Smallest Size
- » Highest Power Density
- » Most Intelligent and Flexible

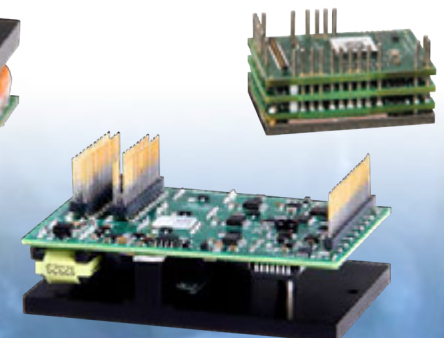

Extended Environment Servo Drives

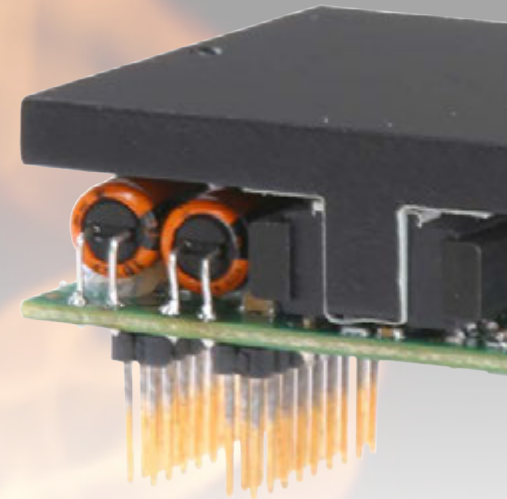

-40°C
AZX/DZX/FX Series

-50°C and lower!
Custom Drives

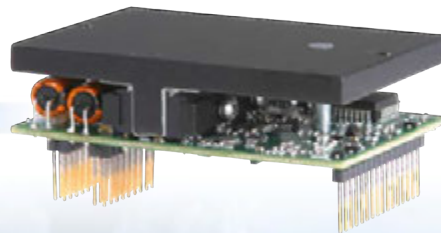

+75°C
DZX Series

+85°C
AZX Series

+95°C
FX Series



+100°C and higher!
Custom Drives

DigiFlex® Performance™ - panel and vehicle mount



Panel mount DigiFlex® Performance™ Servo Drive Models

Example model numbers: DPRALTR-060B080, DPEANIU-C100A400



Network Type	Feedback Type	5V TTL I/O Control Modules	Combine to form model number	DC only Power Modules		Supply (VAC)	Supply (VDC)	Peak Current (A)	Cont. Current (A)	Functional Safety	Dimensions (mm)					
Modbus RTU RS485	Incremental Encoder	DPRALTE	←→	020B080*	-	20-80	20	10	-	-	133 x 90 x 36					
	Resolver	DPRALTR		040B080	-							20-80	40	20	-	191 x 112 x 36
CANopen	Absolute Encoder 1Vp-p Sin/Cos Encoder	DPCANTA	←→	060B080	-	20-80	60	30	-	-	191 x 112 x 36					
	Incremental Encoder	DPCANTE		100B080**	-							20-80	120	60	STO	191 x 112 x 67
	Resolver	DPCANTR		015B200	-							40-190	15	7.5	-	133 x 90 x 36
					025B200							-	20-190	25	12.5	-

*The 020B080 power module can also be combined with most 24 VDC I/O control modules. Dimensions in this configuration change to 167 x 88 x 36.

**The 100B080 power module can also be combined with most 24 VDC I/O control modules. Dimensions in this configuration change to 191 x 112 x 67.



Network Type	Feedback Type	24 VDC I/O Control Modules	Combine to form model number	AC or DC Power Modules		Supply (VAC)	Supply (VDC)	Peak Current (A)	Cont. Current (A)	Functional Safety	Dimensions (mm)				
Modbus RTU RS485	Incremental Encoder	DPRAHIE	←→	015S400	100-240*	127-373	15	7.5	-	STO	177 x 123 x 44				
	Incremental Encoder	DPRANIE		040A400	100-240							40	20	STO	177 x 133 x 49
	Resolver	DPRANIR		C060A400	200-240							255-373	60	30	STO
CANopen	Absolute Encoder 1Vp-p Sin/Cos Encoder	DPCANIA	←→	C100A400	200-240	255-373	100	50	-	STO	257 x 183 x 135				
	Incremental Encoder	DPCANIE		030A800	200-480							255-747	30	15	STO
EtherCAT	Absolute Encoder 1Vp-p Sin/Cos Encoder	DPEANIU	←→	060A800	200-480	255-747	60	30	-	STO	301 x 232 x 139				
	Incremental Encoder														

*Single Phase AC Only



Vehicle mount DigiFlex® Performance™ Servo Drive Models

Example model number: DVC200A100



Network Type	Feedback Type	M/V DigiFlex Control Module	Combine to form model number	Power Modules		Supply (VAC)	Supply (VDC)	Peak Current (A)	Cont. Current (A)	Functional Safety	Dimensions (mm)
CANopen	Incremental Encoder	DVC	←→	250A060	-	20-54	250	150	-	STO	203 x 140 x 60
				200A100	-						

DigiFlex® Performance™ - pcb mount



PCB mount DigiFlex® Performance™ Servo Drive Models

Example model numbers: DZCANTE-040L080, DZPANTU-020B200



Network Type	Feedback Type	5V TTL I/O Control Modules	Combine to form model number	Power Modules	Supply (VDC)	Peak Current (A)	Cont. Current (A)	Functional Safety	Dimensions (mm)
Modbus RTU RS485	Incremental Encoder	DZRALTE	↔	012L080	20-80	12	6	-	64 x 51 x 18
				020L080	10-80	20	12	-	64 x 51 x 23
CANopen	Incremental Encoder	DZCANTE	↔	040L080	10-80	40	20	-	76 x 51 x 23
				060L080	10-80	60	30	-	76 x 51 x 23
				025L200	40-175	25	12.5	-	76 x 51 x 23



Note: These power modules require an external 5VDC logic supply, and can only be combined with the DZxATE control modules.

Network Type	Feedback Type	5V TTL I/O Control Modules	Combine to form model number	Power Modules	Supply (VDC)	Peak Current (A)	Cont. Current (A)	Functional Safety	Dimensions (mm)
CANopen	Absolute Encoder 1Vp-p Sin/Cos Encoder Incremental Encoder	DZCANTU	↔	020B080	20-80	20	10	STO	90 x 64 x 20
				040B080	20-80	40	20	STO	90 x 64 x 20
				020B200	40-175	20	10	STO	90 x 64 x 20
EtherCAT	Absolute Encoder 1Vp-p Sin/Cos Encoder Incremental Encoder	DZEANTU DZSANTU	↔						

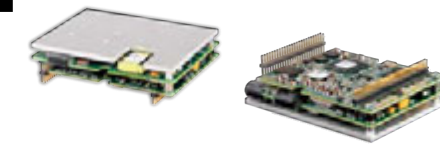

Note: These power modules may either use an external logic supply or utilize the bus voltage supply for logic power, and can only be combined with the DZxANTU control modules.

Note: DZSANTU drives must be used as sub-nodes in a 'DxM' configuration with a DZEANTU node.

POWERLINK Modbus TCP Ethernet	Absolute Encoder 1Vp-p Sin/Cos Encoder Incremental Encoder	DZPANTU
Click&Move® Embedded (Stand-alone)	Absolute Encoder 1Vp-p Sin/Cos Encoder Incremental Encoder	DZMANTU



'DxM'™ Technology allows connectivity of up to 3 DZSANTU (sub-nodes) to a single DZEANTU (node) on an EtherCAT® network, providing control of up to 4 axes of servo motion at a reduced cost.



'DxI/O'™ Technology accommodates 70 additional digital and analog I/O points for each axis in a 'DxM' configuration, up to 280 I/O total!



Mounting Cards	Axes	Max A	Connector Type	Drive Compatibility
MC1XDZx02	1	40	Side-Entry	DZxATE
MC1XDZx02-QD	1	25	Vertical-Entry	DZxATE
MC1XDZx02-HP1	1	60	Side-Entry	DZxATE
MC1XDZPx01	1	40	Side-Entry	DZxANTU
MC4XDZP01	4	40	Side-Entry	DZE/DZS



PCB mount DigiFlex® Performance™ Servo Drive Models Extended Environment

Example model number: DZXRALTE-015L080

Network Type	Feedback Type	5V TTL I/O Control Modules	Combine to form model number	Power Modules	Supply (VDC)	Peak Current (A)	Cont. Current (A)	Functional Safety	Dimensions (mm)
Modbus RTU RS485	Incremental Encoder	DZXRALTE	↔	008L080	10-80	8	4	-	64 x 51 x 23
				015L080	10-80	15	7.5	-	64 x 51 x 23
CANopen	Incremental Encoder	DZXCANTE	↔	040L080	10-80	40	20	-	76 x 51 x 23



AxCent™ - panel and vehicle mount



Panel mount AxCent™ Servo Drive Models



Model Number	Supply (VAC)	Supply (VDC)	Peak Current (A)	Cont. Current (A)	Dimensions (mm)	Operating Mode
AB15A100	-	20-80	15	7.5	129 x 76 x 25	Current, Duty Cycle, Encoder Velocity
AB25A100	-	20-80	25	15	129 x 76 x 25	Current, Duty Cycle, Encoder Velocity
AB30A100	-	20-80	30	15	187 x 109 x 27	Current, Duty Cycle, Encoder Velocity, Hall Velocity, Tachometer Velocity
AB50A100	-	20-80	50	25	187 x 109 x 27	Current, Duty Cycle, Encoder Velocity, Hall Velocity, Tachometer Velocity
AB20A200	-	40-175	20	12	129 x 76 x 25	Current, Duty Cycle, Encoder Velocity
AB30A200	-	40-175	30	15	187 x 109 x 27	Current, Duty Cycle, Encoder Velocity, Hall Velocity, Tachometer Velocity
AB30A200I*	-	40-175	30	15	187 x 109 x 27	Current, Duty Cycle, Encoder Velocity, Hall Velocity, Tachometer Velocity
AB50A200	-	40-175	50	25	187 x 109 x 27	Current, Duty Cycle, Encoder Velocity, Hall Velocity, Tachometer Velocity
AB50A200I*	-	40-175	50	25	187 x 109 x 27	Current, Duty Cycle, Encoder Velocity, Hall Velocity, Tachometer Velocity
B30A40	-	60-400	30	15	203 x 143 x 41	Current, Duty Cycle, Encoder Velocity, Hall Velocity
AB30A200AC	30-125	-	30	15	187 x 109 x 62	Current, Duty Cycle, Encoder Velocity, Hall Velocity, Tachometer Velocity
B30A40AC	45-265	60-400	30	15	203 x 166 x 103	Current, Duty Cycle, Encoder Velocity, Hall Velocity
B060A400AC	200-240	255-373	60	30	257 x 183 x 84	Current, Duty Cycle, Encoder Velocity, Hall Velocity, Voltage, IR Comp
B100A400AC	200-240	255-373	100	50	257 x 183 x 135	Current, Duty Cycle, Encoder Velocity, Hall Velocity, Voltage, IR Comp

*Isolation between high and low power signals.



Vehicle mount AxCent™ Servo Drive Models

Example model number: AVB125A200



Applications	M/V AxCent Control Modules	Combine to form model number	DC Power Modules	Supply (VDC)	Peak Current (A)	Cont. Current (A)	Dimensions (mm)
Electric Mobility and Vehicle	AVB	↔	250A060	20-54	250	150	203 x 140 x 60
General Industrial	AB		200A100	20-80	200	125	203 x 140 x 60
			125A200	40-175	125	80	203 x 140 x 60
			100C200	40-175	100	100	203 x 140 x 60



PCB mount AxCent™ Servo Drive Models

Example model number: AZBE40A8



Operating Mode	Control Modules	Combine to form model number	Power Modules	Supply (VDC)	Peak Current (A)	Cont. Current (A)	Dimensions (mm)
Current	AZB	↔	10A4	10-36	10	5	38 x 38 x 7
Duty Cycle	AZBD*		10A4IC*	10-36	10	5	38 x 38 x 17
Torque Mode PWM	AZBDC		6A8	20-80	6	3	64 x 51 x 17
			12A8	20-80	12	6	64 x 51 x 17
Encoder Velocity Duty Cycle	AZBE		20A8	10-80	20	12	64 x 51 x 23
			40A8	10-80	40	20	76 x 51 x 23
Hall Velocity Duty Cycle	AZBH		60A8	10-80	60	30	76 x 51 x 23
		25A20	40-175	25	12.5	76 x 51 x 23	

*AZBD control module only compatible with 10A4xx power modules.

*10A4IC models are a drive and interface card assembly; interface card is soldered to the drive and features quick-disconnect connectors.



Mounting Cards	Axes	Max A	Connector Type	Drive Compatibility
MC1XAZ01	1	25	Vertical-Entry	AZ/AZX...
MC1XAZ01-HR	1	60	Side-Entry	AZ/AZX...
MC1XAZ02	1	10	Side-Entry	AZ...10A4



PCB mount AxCent™ Servo Drive Models Extended Environment

Example model number: AZXBH15A8

Operating Mode	Control Modules	Combine to form model number	Power Modules	Supply (VDC)	Peak Current (A)	Cont. Current (A)	Dimensions (mm)
Current	AZXB	↔	8A8	10-80	8	4	64 x 51 x 23
Encoder Velocity Duty Cycle	AZXBH		15A8	10-80	15	7.5	64 x 51 x 23
			25A8	10-80	25	12.5	76 x 51 x 23
Hall Velocity Duty Cycle	AZXBH		40A8	10-80	40	20	76 x 51 x 23
			16A20*	40-175	16	8	76 x 51 x 23
Torque Mode PWM	AZXBDC						

*The 16A20 power module can only be combined with the AZXBH control module. Contact us for availability with other control modules.





The C&M automation system consists of two parts:

- Software - used to create motion, PLC code, and an HMI
- Hardware - a PC, a stand-alone controller, servo drive(s), and networked I/O as needed

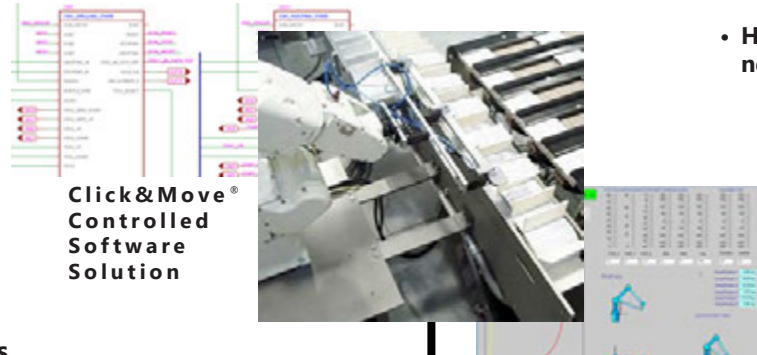

Connectivity Possibilities

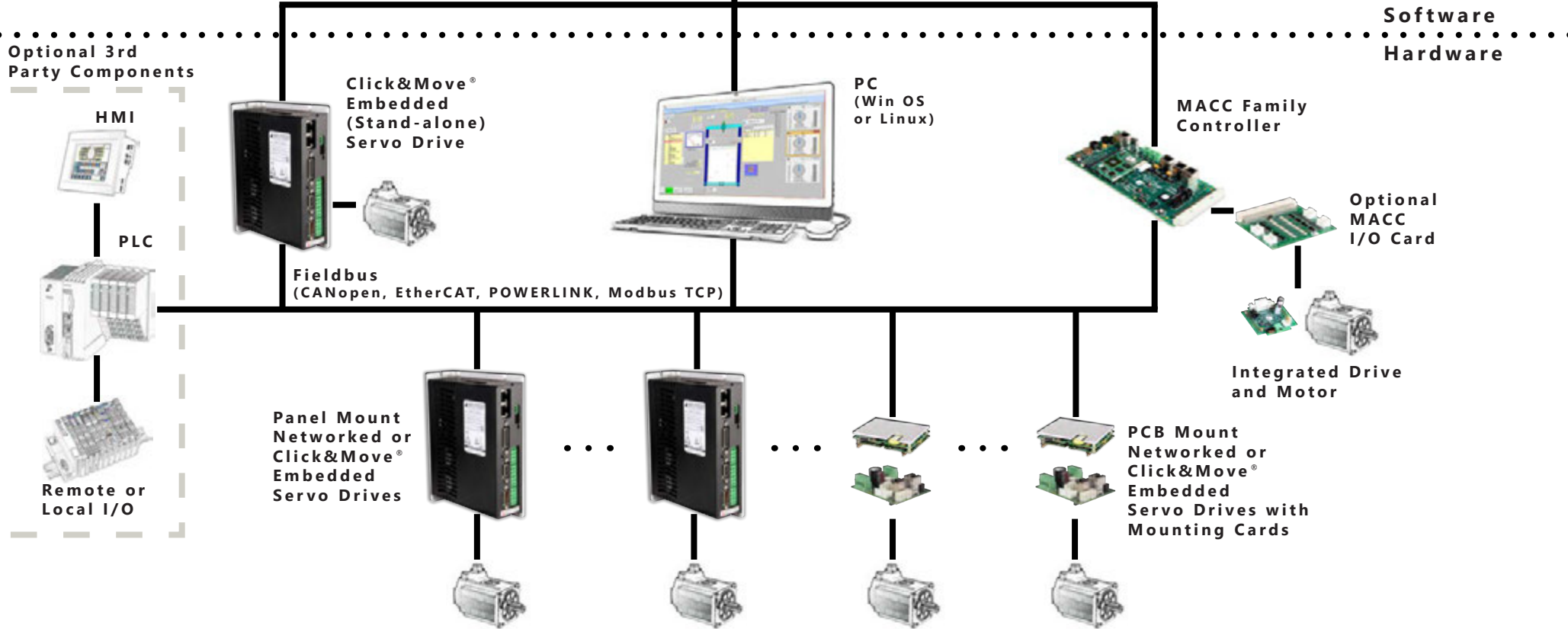

Click&Move® (C&M) is an automation solution designed for OEMs, systems integrators, and end users. C&M can include motion control, PLC logic, local I/O, and networked I/O. Applications can be simple, single-axis with minimal I/O to complex, multi-axes running in real-time.

- **Combines Motion, PLC and HMI control**
- **Fully compliant with PLCopen, the global standard for industrial control programming**
- **Fully IEC 61131-3 compliant using graphical Function Block Diagrams (FBDs) (pre-configured or user-defined)**
- **FBDs compiled to ANSI C++ source code**
- **Project logic is based on state machine architecture**
- **Multiple platforms supported: PC (Win OS and Linux), stand-alone controller (MACC), and *ADVANCED* Motion Controls® servo drives**
- **Supports CANopen®, EtherCAT®, POWERLINK, and Modbus TCP network protocols**
- **Controls multi-axis networks or Click&Move® embedded stand-alone drives**



Click&Move® is IIoT and Industry 4.0 ready!

- **Supports big data mining via both wired and wireless connectivity to the Cloud and local databases**
- **Broad FB Class libraries support “Smart Machine” design**
- **Supports distributed control across networked machines**
- **Incorporates the use of UID/GUID for runtime nodes**
- **SMEM (Shared Memory Interface) allows communication between disparate platforms on hardware/software levels**

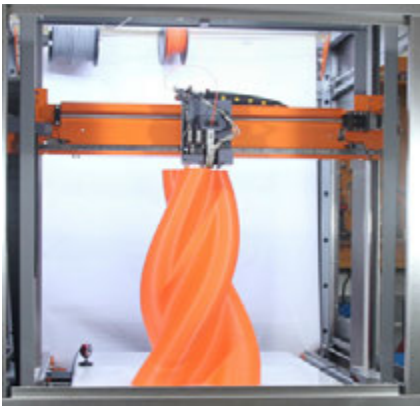

Click&Move® Application Examples

- **Packaging**
- **Wire Crimping**
- **Arc Welding**
- **Plasma Cutting**
- **Fixed Robotics**
- **3D Printing**
- **AGVs**
- **Industrial Actuators**
- **Lab Automation**
- **Communications Telemetry**
- **Laser Engraving**
- **...and many more!**

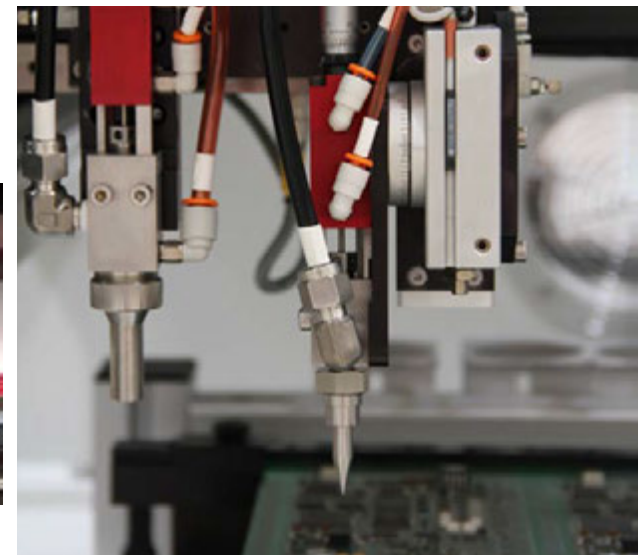

Click&Move® Automation Solution

The C&M Integrated Development Environment (IDE) provides the user with a programming environment for a range of applications: motion, PLC machine control, G-code file handling for CNC apps, process control, and robotics.

The IDE consists of an off-the-shelf graphics editor to create and modify FBD-based logic schematics and HMI screens, debug application code, organize and archive application code, merge and compare code, and automate the build/compile status.

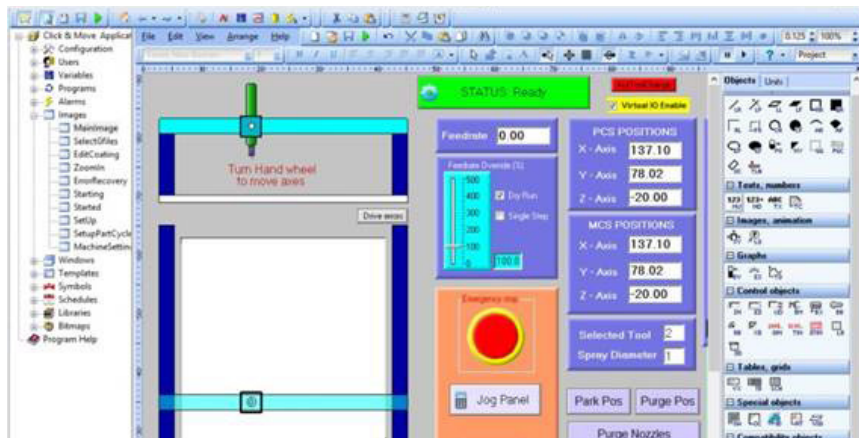

Click&Move® HMI

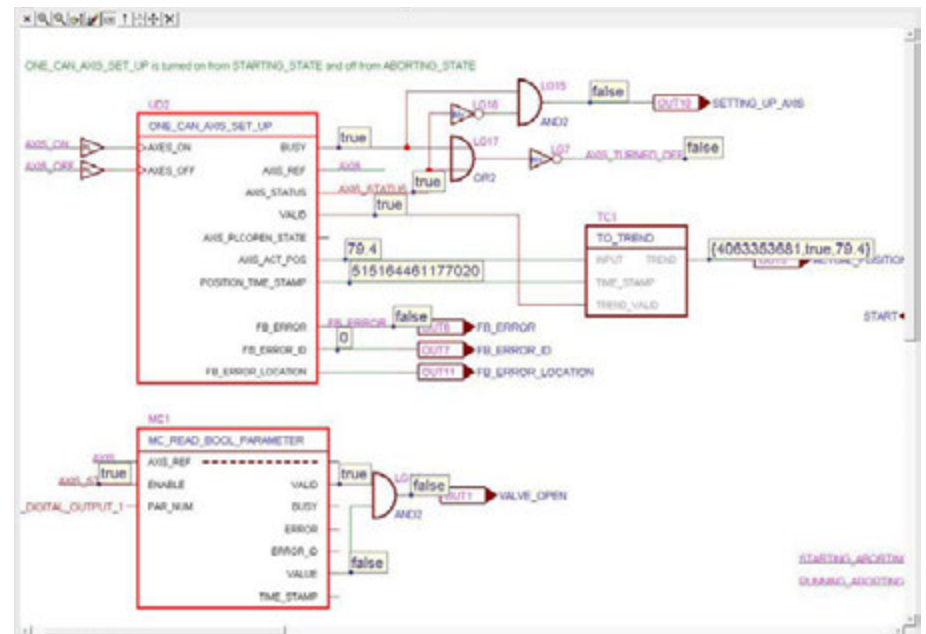

Graphical Debugger

- Windows-based FBD-development system with common pull-down menus
- The HMI displays live information, and alters variables during real-time operation
- Virtual axes for motion simulation
- Graphical and text-based debugging tools
- Extensive built-in Help
 - » Tutorials
 - » Demos
 - » Example Applications
 - » White Papers
- External database links
- Multiple example applications

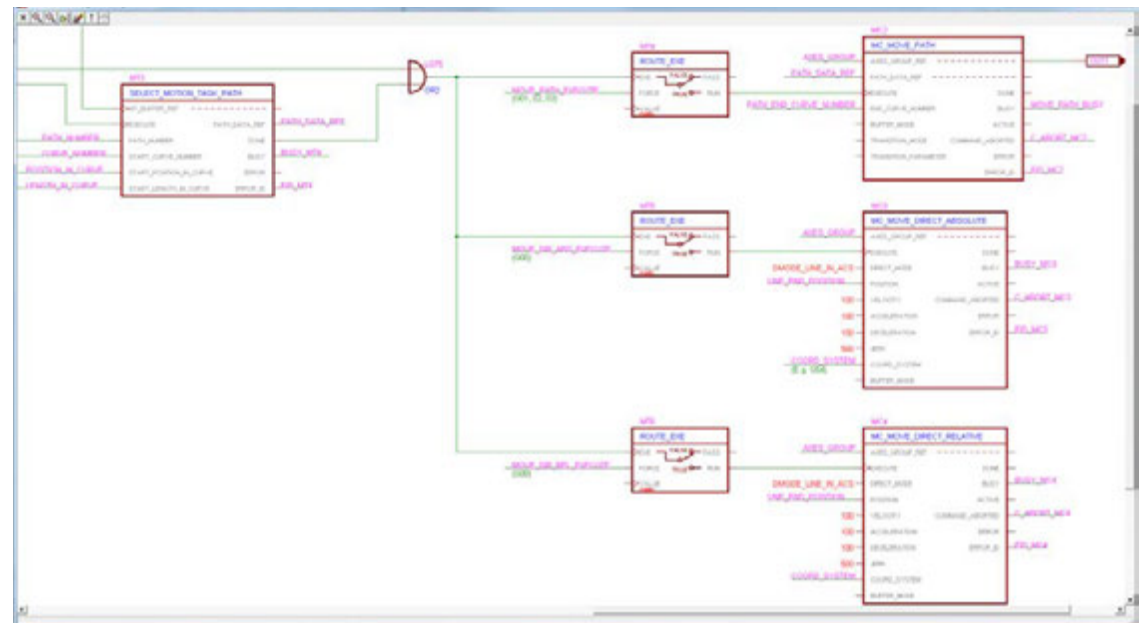

FBD Editor

MACC Controller Family

Motion Automation Control Cards (MACC) are general purpose motion/automation controllers with embedded Click&Move® capability. Operating from a 24VDC power supply, MACC controllers can control DigiFlex® Performance™ servo drives over CANopen®, EtherCAT®, POWERLINK, or Modbus TCP networks. Additionally, the optional plug-in MACC I/O Modules enable control of non-networked AxCent™ or DigiFlex® Performance™ servo drives using traditional commands such as Step/Dir, ±10V Analog, and PWM/Dir.

- » **MACC with Network Drives and Network I/O Module** - This solution can meet demands for drive and I/O command update rates in the few hundred microseconds range. The MACC integrates field bus masters directly or they can be installed into an external PC.
- » **MACC with Non-Network Drives** - Non-networked servo drives, combined with the MACC, provide a system with the lowest overall cost. This solution can meet demands for drive and I/O command update rates in the 50 microsecond range. In this case, motor feedback connections are made to the external I/O module's dedicated inputs.

MACC02



As a stand-alone controller, the MACC02 can take the place of a PC in a control system to reduce cost, or can be configured to work in conjunction with a PC where the MACC02 handles the real-time and time-critical processes such as motion control, and the PC handles less time-critical processes such as the HMI.

- ARM Cortex-A9 microprocessor
- Micro SD card storage
- Real-Time Linux
- Real-Time clock
- Full PLC Logic for machine control
- Fieldbus I/O connectivity
- Multi-axes motion control
- CANopen, EtherCAT, POWERLINK, or Modbus TCP master capability
- WLAN and Bluetooth compatible

MACC11



The MACC11 (μMACC) is designed to be a compact, low-cost controller for machine automation and/or process control applications. Based on the firmware loaded, the MACC11 can control up to 6 axes of servos or steppers, servo drives via the CAN bus, or 2 servo axes via PWM signals.

- 32-bit 120 MHz Risc processor
- 256 kbyte zero wait state SRAM for data
- 1 Mbyte FLASH for firmware and user program storage
- C Programmable
- Micro SD card storage
- RTC with battery backup
- 6 12-bit analog inputs
- 2 11-bit analog outputs
- 9 digital I/Os
- 100 Mbit Ethernet
- USB 2.0 full speed peripheral for firmware update purposes
- Isolated CAN bus and RS485/232

MACC I/O Modules

The MACCIO modules feature the necessary digital and analog I/O to fulfill any application requirement. These cards are partially or fully customizable to fit the application specifications and budget. All of the different MACCIO modules are compatible with all models of the MACC Controller Family.

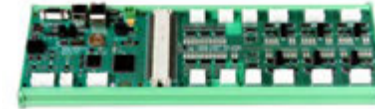

MACCIO1



- 8 16-bit analog inputs
- 8 16-bit digital inputs
- 16 optocoupled digital inputs
- 16 optocoupled digital outputs
- 2x4 isolated high speed RS422 differential outputs
- 4 isolated high speed RS422 differential inputs
- 4 incremental or EnDat 2.0 encoder inputs (population option)

MACCIO2



- 16 optocoupled digital inputs
- 16 optocoupled digital outputs

MACCIO3



- 6 stages for Step/Dir drive control (isolation population option)
 - » 4 high speed RS422 differential outputs (per stage)
 - » 2 high speed RS422 differential inputs (per stage)
- RS422 inputs for 4 incremental handwheels
- 12 optocoupled digital inputs
- 12 optocoupled digital outputs
- 2 high speed optocoupled digital inputs

MACCIO4



- 4 stages for Step/Dir drive control
 - » 4 non-isolated digital outputs (open collector darlington)
 - » 4 non-isolated digital inputs
- 4 independent encoder inputs supporting encoders or handwheels



DriveLibrary™

DriveLibrary™ is a motion control API for controlling *ADVANCED* Motion Controls' DigiFlex® Performance™ servo drives. Using a pre-defined set of motion functions, a programmer can easily command motion profiles for a single-axis and multiple uncoordinated axes. DriveLibrary is designed to allow software developers without expertise in drive control to effectively develop motion applications.

- C++ Static Library
- Based on Industry Standard PLCopen Function Blocks
- CAN and RS232 Communication

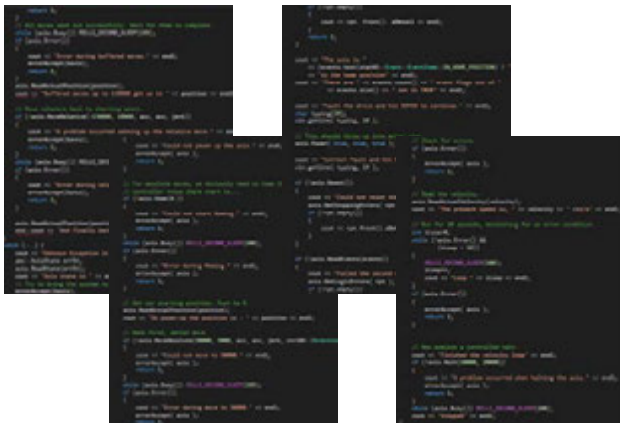

Compiles and runs on Windows OS with Visual Studio compatibility

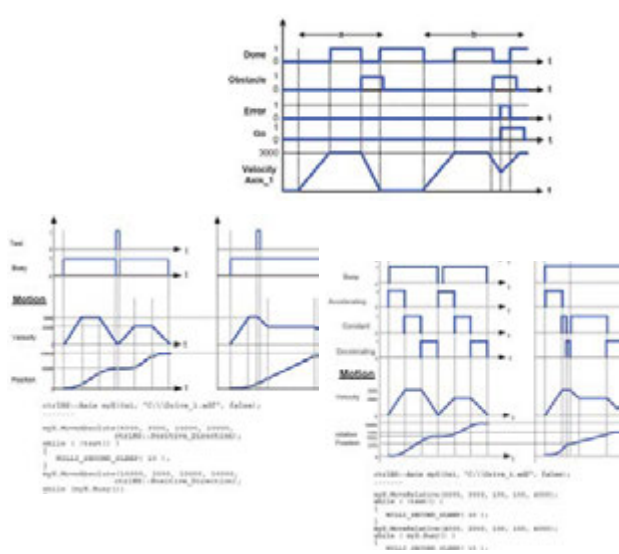

Complex motion profiles contained in reusable function block modules

```

int main(int argc, char* argv[])
{
    // Load the system configuration file
    if (!loadSystem(asfConfigFile))
    {
        cout << "Error loading system file " << asfConfigFile << endl;
        return 1;
    }

    // Initialize an Axis named axis using the axisName variable
    if (!axis.axis(axisName))
    {
        // Failure of Init configurations
        // Do a simple absolute move to 50,000 counts at a maximum velocity to complete the move
        if (!axis.MoveAbsolute(50000, 5000, acc, acc, jerk, ctrlMS, ctrlMS))
        {
            cout << "Could not move to 50000." << endl;
            errorAccept(axis);
            return 1;
        }
    }

    // Setup namespaces for easier use of various functions - see axis
    namespace control;
    using std::cout; //Function to print to console
    using std::endl; //Prints an endline when using cout
    namespace ctrlMS = axis::motion::control;
    namespace hystMS = axis::motion::hyst;
    namespace statusMS = axis::motion::drive::model::status;

    //Declare a basic error handling function that takes an axis object
}
    
```

Uses C++ as the base programming language

Simplified Motion Planning

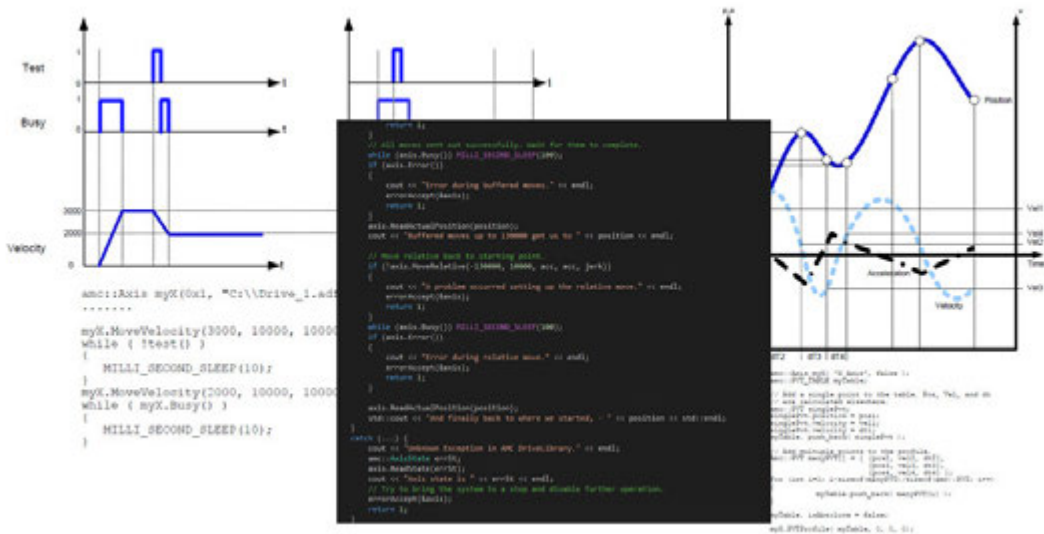

- Intuitive motion profile design focusing on the dynamic properties of the system: position, velocity, and acceleration
- Straightforward motion functions allow a programmer to have basic drive commands and motion profiles operational in a minimal amount of time
- Time-critical control and coordination handled by the drive, allowing a sequential approach to programming
- Axis behavior defined by the state model
- Robust error-handling behavior and fault condition reporting
- Drive configuration file set up in DriveWare®, then loaded through DriveLibrary™

Ideal for use in:

- Precision velocity control
- Repetitive tasks (single-axis or multiple uncoordinated axes)
- I/O-driven tasks
- Grinding
- Accelerated Life Test machines
- Drilling
- ...And many more!

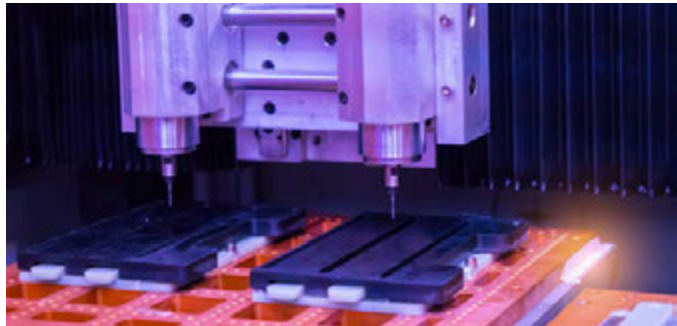
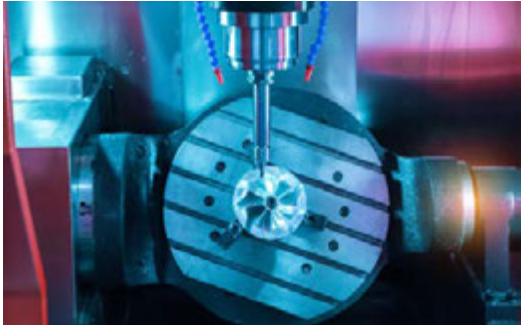



ACE™

ACE™ (AMC Configuration Environment) is the configuration software used to commission and troubleshoot FlexPro™ servo drives. With added capabilities to maximize the performance of our IMPACT architecture, ACE is the most versatile drive commissioning software available.



- Easy-to-use interface common to everyday applications
- Configuration and diagnostics of all digital and analog inputs and outputs
- Real-time Status Panel provides event and fault monitoring and history
- Universal feedback and motor support with AutoComm commutation routine



DriveWare®

DriveWare® 7 is the configuration software used to commission and troubleshoot DigiFlex® Performance™ servo drives. Powerful, reliable, and proven, DriveWare provides the tools necessary to maximize the performance of your digital drive system.

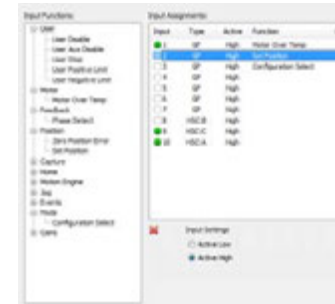

- Real-time gain adjustment to optimize tuning and achieve the highest performance
- On-the-fly Mode Switching
- On-the-fly Gain Set Switching
- Drive and motor limits and events all configurable within the software

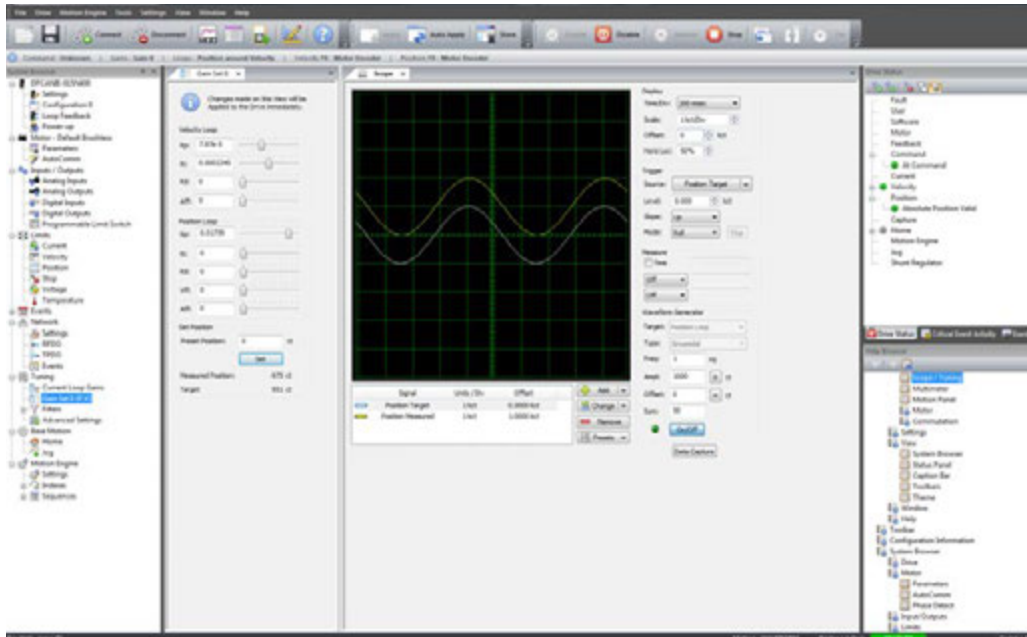

- Built-in Digital Oscilloscope and Multimeter to monitor real-time internal drive signals
- Two independent Programmable Limit Switches are configurable directly within the software or by using network commands
- CANopen, EtherCAT, POWERLINK, Modbus, RS485, and Ethernet TCP/IP network compatibility

Both ACE and DriveWare are available as free downloads from our website, www.a-m-c.com.

Motion Engine

The Motion Engine is embedded motion controller functionality in all FlexPro™ and DigiFlex® Performace™ servo drives.

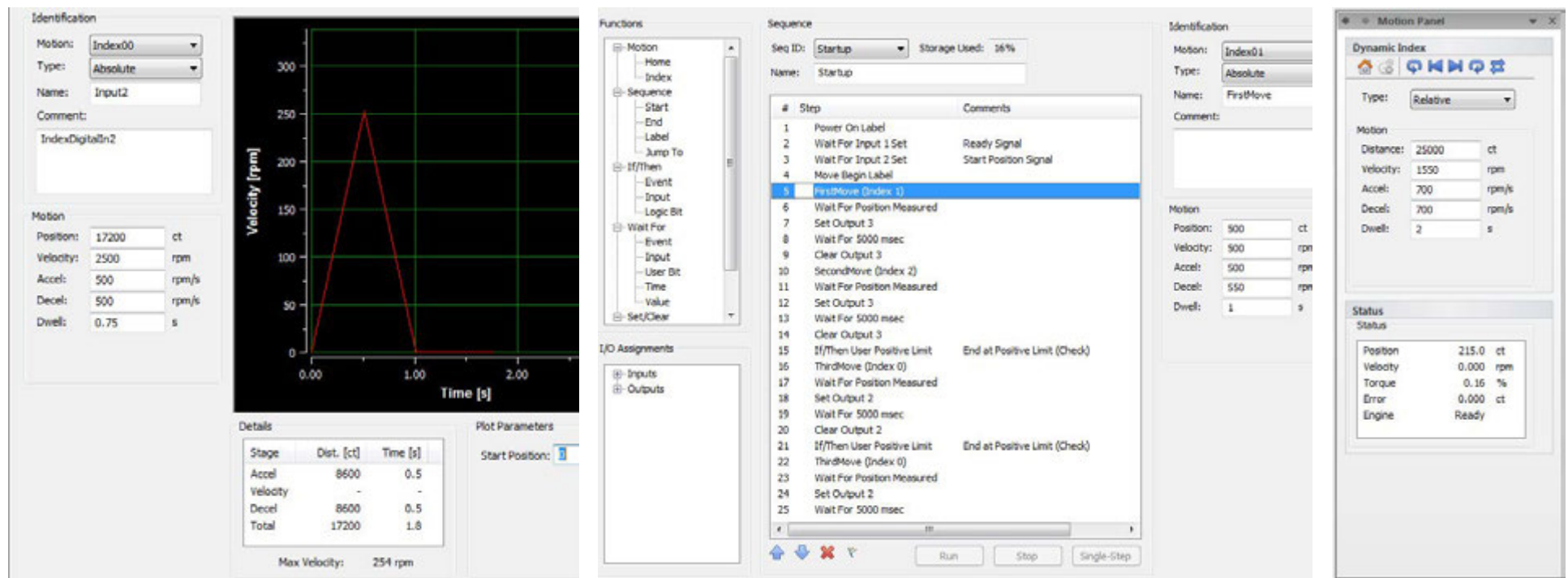

Create up to 16 unique Index tasks by defining position, velocity, and acceleration/ deceleration values.

Indexes can be either Relative or Absolute motion profiles

Indexes are activated using the Motion Panel, digital inputs, or by using an external network command

Indexes can be combined with Homing routines and other control functions to form up to 16 different Sequences

Sequences can be configured to initiate on power-up, via a digital input, or over the network

Ideal for use in:

Material Handling

Conveyed Systems

Feed-to-Length Systems

Packaging

Lab Automation

...And many more!

Customs Capabilities



ADVANCED Motion Controls - An Automation Resource

By selecting *ADVANCED* Motion Controls as your custom servo drive partner you will be adding an integral member to your design engineering team with multi-industry expertise.

Our customers have direct access to our engineering teams who not only listen to the customer's needs but also understand system integration.

Engineer-to-Engineer interaction with our customers is key to our ability to address your technical and technology needs. We listen to your needs and we listen to your requests.

Our innovative engineers continually push the limits of technology to meet the anticipated demands of the motion control market.

Custom servo drives are built by the same people on the same in-house production lines as standard products. Existing DigiFlex® Performance™ and AxCent™ designs can be modified based on the application and customer need. Both of these abilities enable rapid development, fast delivery, and exceptional reliability for OEMs.

We can support and sell optimized solutions to customers as if they were standard products. We create whatever you specify.



- Custom servo drive solutions for both analog and digital designs
- Further customization for digital products available with customer-dedicated firmware
- Private label software for digital drive commissioning
- Communication protocol language subsets for quick-turn solutions

Networked Servo Solutions



- Networking options are not limited to those available on standard products - our experience in multiple communication protocols allows us to provide custom digital drives for a variety of network types



In-house Design & Manufacturing

- Facility specifically designed to integrate Engineering, Manufacturing, Testing, and Support in a single location
- Four in-house engineering labs
- Two full production lines building custom, prototype, and production units
- Unmatched scheduling flexibility and quality control in manufacturing our wide range of products

Customs Process

Design and Development

- Onsite visits by Sales Engineers, Design Engineers, and/or Applications Engineers for hands-on application understanding and specification discovery
- High-level internal review of preliminary specifications, quantities, cost targets, commercial issues, etc.
- Budgetary proposal
- Preliminary customer approval
- **ADVANCED** Motion Controls internal review with Sales Manager, Product Manager, Applications Engineering, Design Engineering Manager and others needed to complete the Project Requirements Document (PRD)
- Formal customer approval of PRD
- **ADVANCED** Motion Controls submits development proposal with following detail:
 - Development schedule with milestones
 - NRE
 - Agency certification and testing
 - Prototype and Production costs

Prototype and Qualification

- Customer initiates by placing order for a limited number of prototypes
- Major milestone review
- Prototype ships with same process as production product
- Optional on-site integration
- Customer testing in-parallel with **ADVANCED** Motion Controls' in-house compliance testing and DVT
- Change orders and iterations
- Customer sign-off on prototypes
- Production

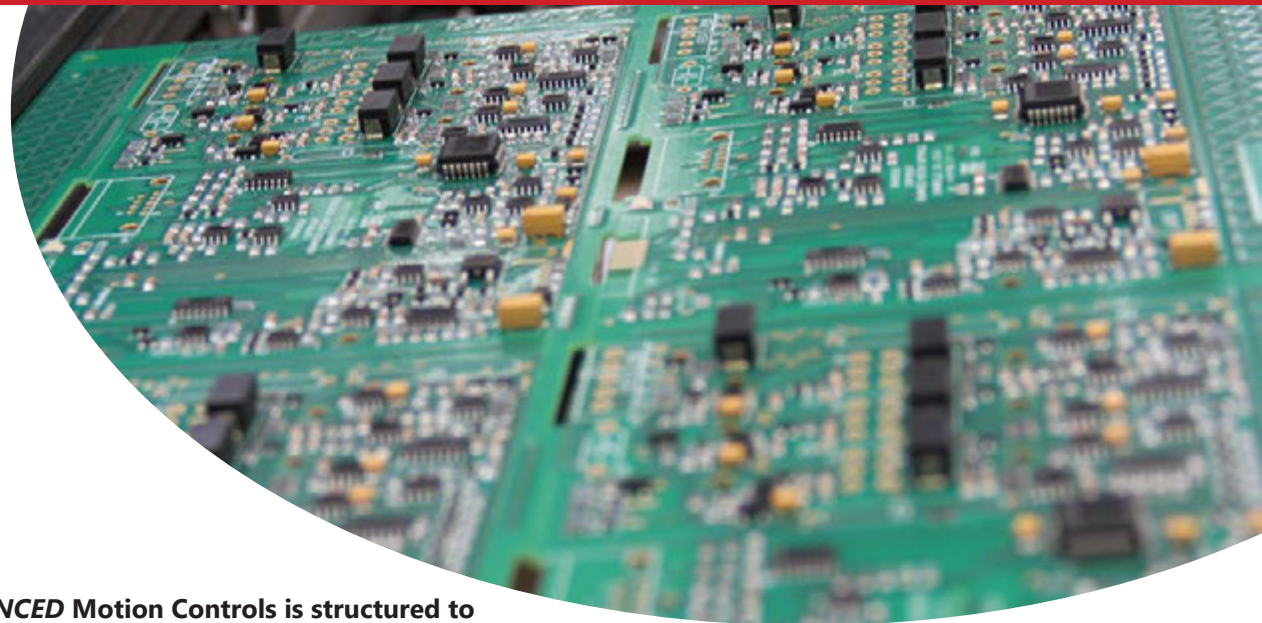

ADVANCED Motion Controls is structured to facilitate delivering high quality optimized servo products to OEMs

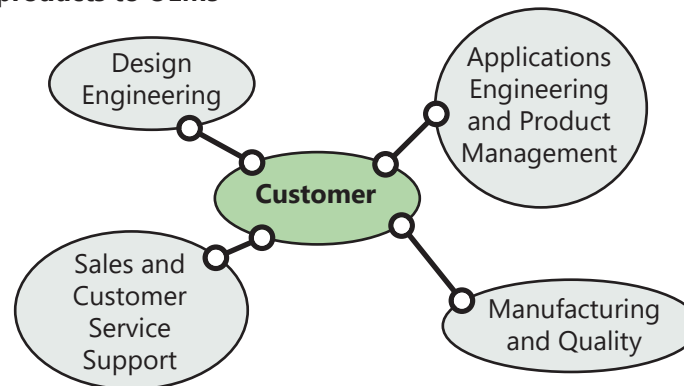

Customers have direct access to all departments within **ADVANCED** Motion Controls. Sales, Applications, and Engineering support custom products throughout the lifetime of the product, with additional on-site assistance available. We make the custom process transparent to our customers, and encourage quality audits and visits to our factory so customers can gain an understanding of our capabilities and corporate structure.

A custom design with **ADVANCED Motion Controls has many advantages when it comes to cost and lead times**

- Tailored to meet the exact form, fit, and function of our customer's requirements
- Optimized custom designs will likely cost less due to reduction of components or features not needed for specific system
- Our experience and in-house facilities will produce reliable custom solutions faster than any other supplier on the market

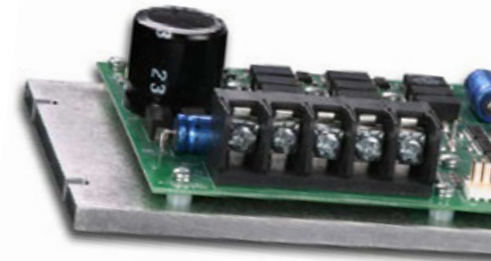

Example Custom Solutions

Additional Solutions

- PCB mount drive with modified switching frequency, current capability, current monitor scaling, and custom tuning for automotive test machine
- Military weapons turret using drive with optimized temperature requirements and specialized FETs
- Photovoltaic solar-tracking array utilizing embedded PCB mount drives with custom peak current specifications

Parameter Optimization

ADVANCED Motion Controls offers hundreds of standard servo drives over a wide range of size, power output, and current capability. However, to achieve the best possible performance in certain system designs, some standard servo drives can be modified to optimally match the customer requirements. Whether optimizing one parameter, such as an increase in continuous current output, or multiple parameters at the circuit level, PCB level, or product hardware, *ADVANCED* Motion Controls is capable of "fine-tuning" our servo drives to best meet your application's needs.

Automated Coordinate Measuring Machines

- Custom PCB mount drives on 35 different models of customer's coordinate measurement machines
- Standard PCB mount drive was tested and met the application requirements, performing better than the competition or existing solutions
- *ADVANCED* Motion Controls' applications and design engineers worked with customer to improve performance even further
- Custom circuit-level current-loop tuning specific to customer's application yielded even greater results
- Precision tuning now shows no measurable difference in performance between production machines



Portable Chest Compression Device

- Single-axis machine that winds a belt with a rotary motor to provide automatic chest compressions
- Standard drive used for testing; size, shape, and functionality didn't quite fit for production
- Custom drive developed in 7 weeks from design to delivery
- 75% increase in peak power
- 25% smaller than standard drive
- Integrated heat sink into machine's cooling tunnel
- Optimized functionality with "no extras" to meet customer's exact set of needs
- Operating mode modified to mimic kinematic functions

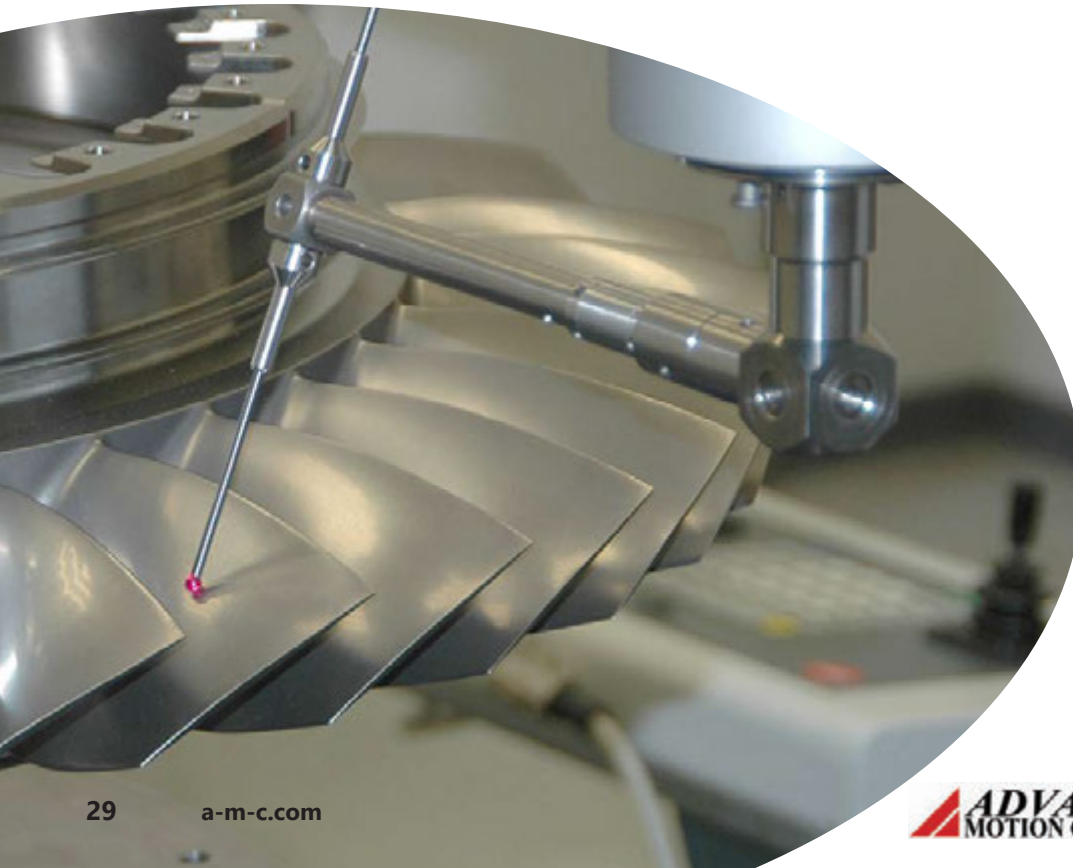

Embedded Drives

ADVANCED Motion Controls' embedded PCB mount drives began as a custom design project and extension of the product line - unmatched power density in a small package that can be embedded directly into a customer's PCB. This then became a standard product line over a wider range of power and capabilities. For further optimization, a custom PCB mount design will provide system designers with complete PCB-integration while retaining all the functionality of larger digital and analog drives with a design tailored to fit the exact system requirements. A common footprint and available mounting cards throughout the PCB mount product line streamlines the prototype and testing phase, allowing custom design iterations to be swiftly modified and re-introduced to the system with minimal hassle.

Artificial Heart Pump System

- Artificial heart pump system for patients awaiting heart transplant
- PCB mount drive powering pump mechanics for ambulatory hospital system and portable variation of product
- ADVANCED Motion Controls' sales and design team worked with customer to modify initial custom drive design to accommodate requirements for 2nd generation product
- Drives shipped with preset switch and potentiometer configuration to ensure standardization
- Increased over-temperature headroom to allow for extra reliability



Automated Guided Cart (AGC) Control

- DigiFlex® Performance™ PCB mount drive and mounting card driving AGC in factory/warehouse environments
- Increased continuous current capability from standard digital networked drive to match customer application requirements
- DC voltage supply range modified for system specifications
- Mounting card with custom connectors to ease integration and installation used on production AGC



Additional Solutions

- PCB mount drive for brushless motor driving plasma cutting head machines
- Network capable PCB mount drives and mounting cards for 5 axes in a dental milling machine
- Robotic welding system using reduced current PCB mount drive with additional operating mode



Example Custom Solutions



Multiple Servo Axes

For servo systems that operate in more than one dimension of motion, a custom drive specially designed to control all motion axes will greatly simplify a project and improve system reliability. Multiple servo axes of motion built into one unit will eliminate redundant components, save space, and reduce overall cost. *ADVANCED* Motion Controls' experience in developing, designing, and integrating multi-axis platforms across a variety of applications and power ranges will yield the best possible solution for your custom project.

ROV Gripper Arm and Wheels

- Application utilizes two custom dual-axis drives to power both the ROV wheels and gripper arm 'shoulder'
- Initial testing with standard single-axis servo drive on ROV wheels only to determine capability
- *ADVANCED* Motion Controls' Sales Engineering team visited customer to help solve design issues
- Solution recommended as custom dual-axis drives with mechanically integrated heat sink to power wheels and ROV arm
- Successfully reduced customer component count and cost, and solved gearing, tuning, and heat dissipation issues



Dual-processor Servo Drive with Integrated Control Card

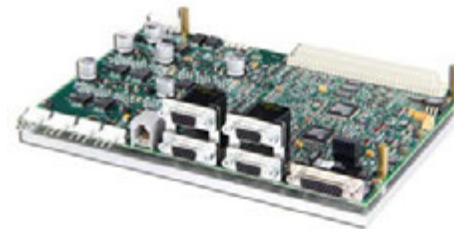

- Up to 4 axes of servo control for moving coil actuator technology
- Two processors handling dual-axis command simultaneously
- 3rd-party motion controller card integrated with drive
- Outer case for drive and controller assembly with customer logo provided by customer to match entire product line

Additional Solutions

- Dual-axis servo drive sized to fit within motorized camera housing
- Dual-axis mounting card with PCB mount drives for X-ray collimator
- Friction free, high reliability magnetic bearing controller using 5-axis mounting card and PCB mount drives assembly



Integration and Ruggedization

System designers are often challenged by having to fit multiple pieces of hardware into a confined area. Motors, cables, controllers, and servo drives must all occupy limited design space. *ADVANCED* Motion Controls has the unique advantage of being able to provide custom servo drives that can be sized exactly to fit the application dimensions, including direct integration into the system hardware. All PCB design and layout is done in-house, allowing your custom drive to be developed and built in the fastest possible time.

Heavy Equipment Engine Temperature Control



- Precise air flow temperature control for heavy industrial machinery
- Available space resulted in custom servo drive solution mounted directly to motor endcap
- Dual-sided PCB allowed for additional power density
- To maximize integration, Hall sensors were included on the servo drive PCB
- Servo drive designed for operating temperatures of -40°C to +112°C
- Controlled over the vehicle's microprocessor via J-1939

Unmanned Submersible Camera

- 8 axes of camera pan and tilt control required for unmanned submersible
- Due to the restricted space within the vehicle, customer needed high power servo drive in a small package
- Standard PCB mount drives were initially considered for the project, but a fully custom design that would fit within the motor housing was developed after discussion with *ADVANCED* Motion Controls' engineers
- Additionally required to withstand pressures of 6000m under water (58900 kPa)
- Customer commanded drive operation with *ADVANCED* Motion Controls' RS485/232 serial protocol



Additional Solutions

- Servo drive baseplate/ heatsink integrated into ROV arm hardware
- Specially-sized servo drive for space requirements in electric vehicle fuel cell
- PCB mount drive heatsink incorporated into dispensing machinery hardware



Example Custom Solutions

Additional Solutions

- PCB mount drive designed to handle excessive shock/vibration for weapons positioning system
- Cold storage conveyor belt systems
- Telemetry tracking antenna installation inside the Arctic Circle

Extended Environment

As motion control technology expands to more industries and varied applications, the rigors that servo drives are expected to survive increase as well. High and low ambient temperature operation, the ability to cope with extreme altitudes and atmospheric pressures, and enhanced shock and vibration resistance are rapidly becoming essential parameters for many projects. Whether designing to meet military standards, or simply for everyday commercial usage in harsh environments, *ADVANCED* Motion Controls is at the forefront of developing custom servo drives to meet the strictest and most unforgiving of requirements.

Cold Weather Aircraft Hoist

- Aircraft hoist designed for extreme cold weather environments
- Standard analog series servo drive initially designed into project
- Development of application specifications led to design of custom M/V™ series motor controller
- Operation in ambient temperatures down to -40°C
- RTV and conformal coating used for rugged environmental requirements



Unmanned Military Robot Motor Actuator



- Drive serves as motor actuator on robot for military/defense applications
- Customer tested project with standard drive
- Power requirements, sizing, and desire for added features led to development of fully custom drive
- Designed to meet MIL-STD-810F for shock and vibration requirements - withstands 260g, 6ms half sine wave shock events in any direction
- Operating temperatures down to -40°C
- Customer specified connectors and CANopen network command

ADVANCED Motion Controls also offers dedicated standard product lines of extended environment PCB mount drives - AZX and DZX drive models come in a variety of control methods and power ranges designed for the harshest thermal and mechanical conditions.



AZX series

DZX series



Specified Software

Providing OEMs with optimal custom solutions will often extend beyond the hardware and circuitry design aspect. Depending on the customer's needs, *ADVANCED* Motion Controls is capable of developing and delivering custom software and firmware packages that bring 'form, fit, and function' to the digital programming level. From fully customized application programming interfaces to optimized firmware and setup software project files, a custom software partnership will offer system designers a servo solution specifically tailored to meet their requirements.

Custom API for Complex Multi-Axis Motion Planning

- Custom multi-axis design for ceiling-mounted X-ray imaging system spanning multiple generations of *ADVANCED* Motion Controls' hardware and firmware
- High-level C++ interface to the *ADVANCED* Motion Controls' EtherCAT® command set using customer-proprietary algorithms
- Includes device storage, I/O capabilities, and support for firmware and configuration downloads
- Full backwards compatibility maintained throughout different drive configurations
- Rigorous regression testing capability to satisfy medical industry requirements for reliability and patient safety
- Combines different power level servo drives into one enclosure to maximize system space



- *ADVANCED* Motion Controls' exclusive DeMultiplexed Motion Technology ('DxM') used to drive multiple axes of motion on an EtherCAT® network
- Single EtherCAT® node uses 'DxM' technology to communicate with multiple slave sub-nodes saving node costs

Private Labeled Drive Configuration Software



- *ADVANCED* Motion Controls' software and hardware provided to private label partner
- Drives and software featured in multi-axis control packages and linear motor and voice coil product lines
- Customer name and logo used in software interface, servo drive labeling, and accompanying documentation

Additional Solutions

- Reduced subset of communication protocol as required by customer's use cases
- Specialized project file pre-loaded into drives prior to shipping
- Custom-tailored firmware to meet application and system requirements



Specialized Motor Operation

With 25 years of experience in designing custom servo drives for a multitude of applications and industries, *ADVANCED* Motion Controls has built up a wealth of knowledge in working with a variety of motor types. From industry-standard brush type and brushless motors to cutting-edge motor technology and everything in-between, *ADVANCED* Motion Controls' can provide a custom servo drive solution developed to meet the specific motor parameters for any application.



Wind Turbine Electric Blade Pitch Control

- Controlling angle of windmill blades for wind energy systems
- Off-the-shelf DigiFlex® Performance™ drives satisfied requirements, but performance could be improved with custom design
- *ADVANCED* Motion Controls' design engineers helped customer troubleshoot AC induction motor tuning issues
- Power capability for custom design increased to 100A peak / 50A continuous with a 3-phase, 380 VAC supply
- Custom IP54 case with cooling fan mounted to drive baseplate

Photopheresis Treatment Machine

- Custom DigiFlex® Performance™ drive powering high-pole count, high torque pancake motors in photopheresis treatment machines used to withdraw, medicate, and return white blood cells to patients
- Design modified to accept AC supply input only per customer requirements
- Increased analog command input accuracy
- Customer-specific firmware and drive commissioning file loaded into drive in-house before shipping



Additional Solutions

- Chemical mechanical planarization tool for high-pole count, direct drive, hollow-shaft motor
- Ultra high switching frequency drive in automotive materials handling robotics
- Unique drive parameters for gyro-stabilized pan and tilt camera with very low inductance motor



EMI Expertise

Servo drives are inherently "noisy" devices - the PWM switching at the heart of servo technology creates EMI issues that can affect other aspects of a system. For EMI sensitive applications or projects that must meet certain EMI requirements, *ADVANCED* Motion Controls is capable of either modifying a standard drive to reduce EMI emissions, or designing a fully custom servo drive to provide best possible EMI reduction.



Long Range Directed Acoustic Hailing and Warning Device

- Shipboard long range hailing system with precise directional capability
- Proof-of-concept testing done with DigiFlex® Performance™ ethernet-capable PCB mount drive
- To reduce cost to customer and minimize hardware footprint, a custom combined mounting card and drive assembly were designed to fit into customer enclosure
- Enhanced EMI filtering added to mounting card PCB
- Customer-specified connectors and encoder power supply added to mounting card to simplify integration into final product
- Utilizes TCP/IP network command and absolute encoder feedback



Tele-manipulated Endoscopic Surgery System

- Robotic surgery system using 2 different custom DigiFlex® Performance™ drive models (6 drives in total for each robot)
- Prototyping done with standard models
- Medical compliance testing led to the development of custom designs to meet stringent EMI and noise immunity requirements
- Tested compliant to IEC60601-1-2 Class A -6dB for emission and immunity standards
- Optical isolation between low and high power circuits
- Design also includes custom PCB shape and layout, custom connectors, and custom baseplate/case

Additional Solutions

- Custom drive with enhanced EMI protection in semiconductor wirebonding machine
- Medical grade emissions and immunity compliant servo drive for cardiovascular X-ray device
- Multi-axis drive with additional filtering and ESD protection for automated warehouse robots





a-m-c.com

3805 Calle Tecate | Camarillo, CA 93012 | 805.389.1935



Partnering with *ADVANCED* Motion Controls

- » **Superior performance and product offering**
- » **Fast delivery to meet your needs**
- » **Worldwide factory trained technical and sales support**
- » **Engineering support available to you on-site**
- » **Close collaboration with, and an extension of, your engineering team**
- » **Diverse industrial experiences and knowledge allows us to improve your systems**
- » **Proud of providing you with the most optimized solutions**
- » **Passionate about your success**

Providing motion control solutions to OEMs is our focus...

Everything's possible